

3875081 G E SOLID STATE
Silicon Controlled Rectifiers

01E 17678 D T-25-17

2N3654, 2N3655, 2N3656, 2N3657, 2N3658, S7412M

File Number 724

35-A Silicon Controlled Rectifiers

For Inverter Applications

Features:

- Fast turn-off time — 10 μ s max.
- High di/dt and dv/dt capability
- Low thermal resistance

RCA-2N3654 to 2N3658, inclusive, and the S7412M* are all-diffused silicon controlled rectifiers (reverse-blocking triode thyristors) intended for high-speed switching applications such as power inverters, switching regulators, and high-current pulse applications. They feature fast turn-off, high dv/dt, and high di/dt characteristics and may be used at frequencies up to 25 kHz.

The 2N3654 to 2N3658 have forward and reverse off-state voltage ratings of 50, 100, 200, 300, and 400 volts, respectively. Type S7412M has a forward and reverse off-state voltage rating of 600 volts.

These SCR's employ a hermetic JEDEC TO-208AA package.

*Formerly RCA Type No. S7432M.

TERMINAL DESIGNATIONS

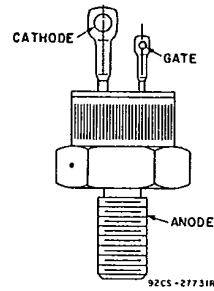

JEDEC TO-208 AA

MAXIMUM RATINGS, Absolute-Maximum Values:

	2N3654	2N3655	2N3656	2N3657	2N3658	S7412M	
*V _{RSOM} †	75	150	300	400	500	700	V
V _{DSOM} †	75	150	300	400	500	700	V
*V _{RRSM} †	50	100	200	300	400	600	V
V _{DROM} †	50	100	200	300	400	600	V
I _{T(RMS)} (T _C = 40°C, $\theta = 180^\circ$)				35			A
I _{T(AV)} (T _C = 40°C, $\theta = 180^\circ$)				25			A
*I _{TSM} : For one full cycle of applied principal voltage 60-Hz (Rectangular wave-pw = 5 ms, t _r = 50 μ s), T _C = 40°C				180			A
*di/dt:							A
V _D = V _{DROM} , I _{GT} = 200 mA, t _r = 0.1 μ s (See Fig. 15)				400			A/ μ s
I _{2t} :							A ² s
T _J = -65 to 120°C, t = 1 to 8.3 ms				165			A ² s
*P _{GM} ‡:							W
Peak (forward or reverse) for 10 μ s maximum, See Fig. 7)				40			W
*P _{G(AV)} ‡:							W
Averaging time = 10 ms maximum				1			W
*T _{stg} *				-65 to 150			°C
*T _C *				-65 to 120			°C
T _r :							°C
During soldering for 10 s maximum (terminal and case)				225			°C
τ_s :							
Recommended				35			in-lbf
Maximum (DO NOT EXCEED)				0.4			kgf-m
				50			in-lbf
				0.57			kgf-m

* In accordance with JEDEC registration data format (JS-14, RDF-1) filed for the JEDEC (2N series) types.

† These values do not apply if there is a positive gate signal. Gate must be open or negatively biased.

‡ Any product of gate current and gate voltage which results in a gate power less than the maximum is permitted.

• For temperature measurement reference point, see Dimensional Outline.

2N3654, 2N3655, 2N3656, 2N3657, 2N3658, S7412M

ELECTRICAL CHARACTERISTICS

At Maximum Ratings Unless Otherwise Specified and at Indicated Case Temperature (T_C)

CHARACTERISTIC	LIMITS			UNITS	
	FOR ALL TYPES Except as Specified				
	MIN.	TYP.	MAX.		
I_{DOM} or I_{ROM} : $V_D = V_{DROM}$ or $V_R = V_{RROM}$, $T_C = 120^\circ\text{C}$ 2N3654, 2N3655, 2N3656, S7412M 2N3657 2N3658	-	2	6*	mA	
v_T : $i_T = 25$ A (peak), $T_C = 25^\circ\text{C}$	-	1.5	2.05*		V
i_{HO} : $T_C = 25^\circ\text{C}$ $T_C = -65^\circ\text{C}$	-	75	150		mA
$T_C = -65^\circ\text{C}$	-	150	350*		
* dv/dt : $V_D = V_{DROM}$, exponential voltage rise, $T_C = 120^\circ\text{C}$ (See Fig. 16)	200	-	-	V/ μs	
I_{GT} : $V_D = 6$ V (dc), $R_L = 4 \Omega$, $T_C = 25^\circ\text{C}$ $V_D = 6$ V (dc), $R_L = 2 \Omega$, $T_C = -65^\circ\text{C}$	-	80	180	mA	
V_{GT} : $V_D = 6$ V (dc), $R_L = 4 \Omega$, $T_C = 25^\circ\text{C}$ $V_D = 6$ V (dc), $R_L = 200 \Omega$, $T_C = 120^\circ\text{C}$ $V_D = 6$ V (dc), $R_L = 2 \Omega$, $T_C = -65^\circ\text{C}$	-	1.5	3		V
$V_D = 6$ V (dc), $R_L = 200 \Omega$, $T_C = 120^\circ\text{C}$	0.25	-	-		
$V_D = 6$ V (dc), $R_L = 2 \Omega$, $T_C = -65^\circ\text{C}$	-	2	4.5*		
* t_q : Rectangular Pulse $V_{DX} = V_{DROM}$, $i_T = 10$ A, pulse duration = 50 μs , $dv/dt = 200$ V/ μs , $-di/dt = 5$ A/ μs , $I_{GT} = 200$ mA at turn-on, $V_{RX} = 15$ V minimum, $V_{GK} = 0$ V at turn-off, $T_C = 120^\circ\text{C}$ (See Figs. 17 & 18)	-	-	10	μs	
Sinusoidal Pulse $V_{DX} = V_{DROM}$, $i_T = 100$ A, pulse duration = 2 μs , $dv/dt = 200$ V/ μs , $V_{RX} = 30$ V minimum, $V_{GK} = 0$ at turn-off, $T_C = 115^\circ\text{C}$ (See Figs. 19 & 20)	-	-	10		
$R_{\theta JC}$	-	0.85	1.7*	$^\circ\text{C}/\text{W}$	

* In accordance with JEDEC registration data format (JS-14, RDF-1) filed for the JEDEC (2N series) types.

2N3654, 2N3655, 2N3656, 2N3657, 2N3658, S7412M

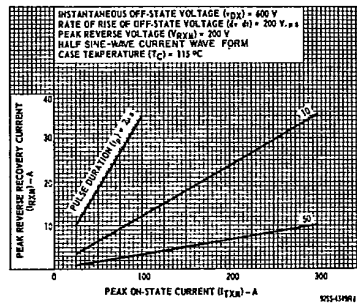

Fig. 7 — Typical variation of peak reverse-recovery current with peak on-state current (half-sine-wave pulse).

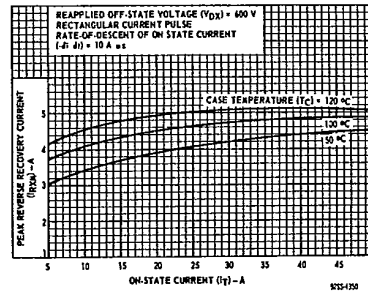

Fig. 8 — Typical variation of peak reverse-recovery current with on-state current (rectangular pulse).

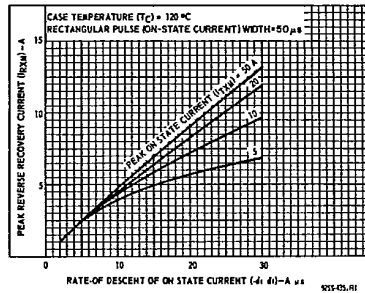

Fig. 9 — Typical variation of peak reverse-recovery current with rate-of-descent of on-state current (rectangular pulse).

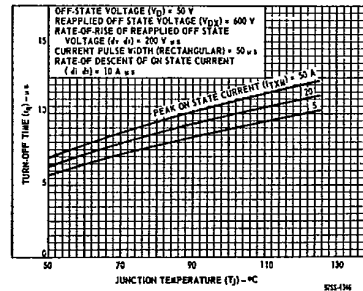

Fig. 10 — Typical variation of turn-off time with junction temperature (rectangular pulse).

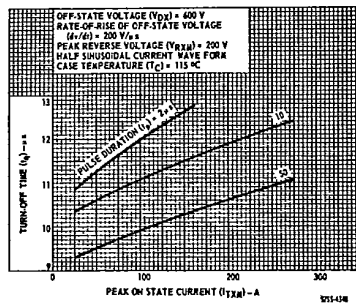

Fig. 11 — Typical variation of turn-off time with peak on-state current (half-sine-wave pulse).

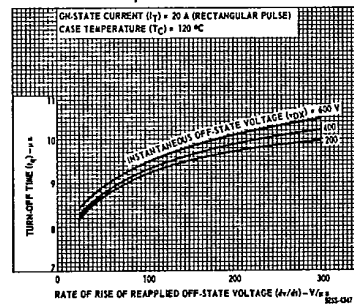

Fig. 12 — Typical variation of turn-off time with rate-of-rise of reapplied off-state voltage (rectangular pulse).

3875081 G E SOLID STATE
Silicon Controlled Rectifiers

01E 17682 D T-25-17

2N3654, 2N3655, 2N3656, 2N3657, 2N3658, S7412M

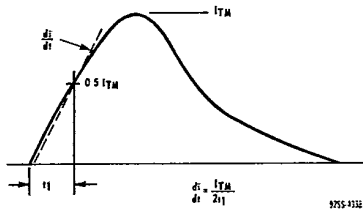

Fig. 13 — Rate-of-change of on-state current with time (defining di/dt).

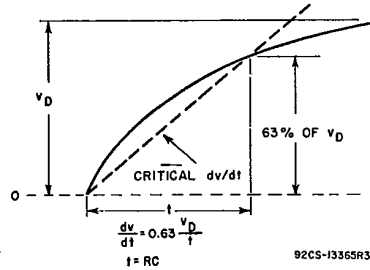

Fig. 14 — Rate-of-rise of off-state voltage with time (defining dv/dt).

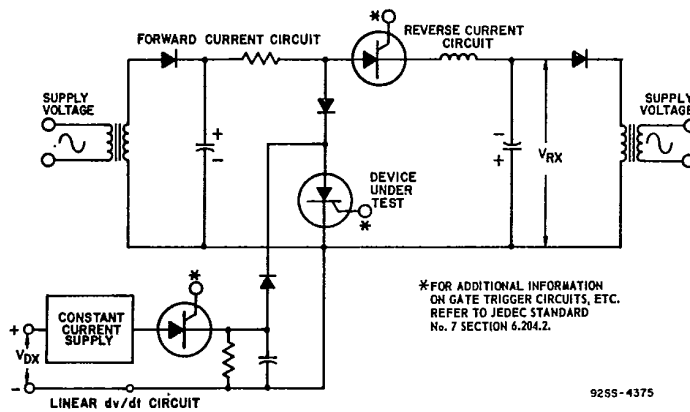

Fig. 15 — Circuit used to measure turn-off time (t_o), rectangular pulse.

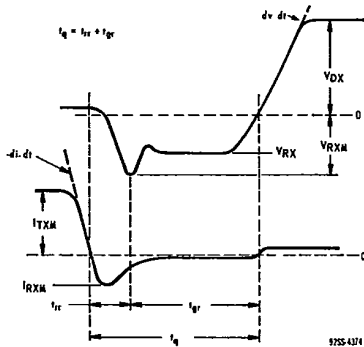

Fig. 16 — Relationship between off-state voltage, reverse voltage, on-state current, and reverse current showing reference points defining turn-off time (t_o), rectangular pulse.

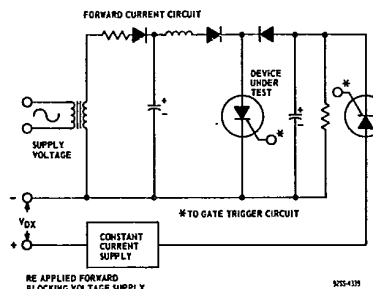

Fig. 17 — Circuit used to measure turn-off time (t_o), half-sine-wave pulse.

2N3654, 2N3655, 2N3656, 2N3657, 2N3658, S7412M

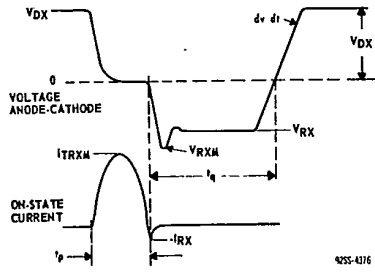

Fig. 18 — Relationship between off-state voltage, reverse voltage, on-state current, and reverse current showing reference points for specification of turn-off (t_o), half-sine-wave pulse.

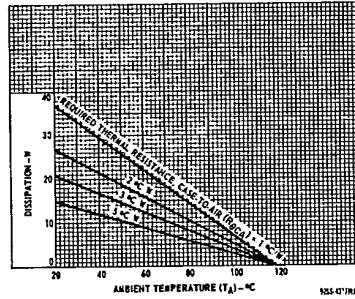

Fig. 19 — Heat sink guidance.