

**SN5420, SN54LS20, SN54S20,  
SN7420, SN74LS20, SN74S20**  
**DUAL 4-INPUT POSITIVE-NAND GATES**  
DECEMBER 1983—REVISED MARCH 1988

- Package Options Include Plastic "Small Outline" Packages, Ceramic Chip Carriers and Flat Packages, and Plastic and Ceramic DIPs
- Dependable Texas Instruments Quality and Reliability

**description**

These devices contain two independent 4-input NAND gates.

The SN5420, SN54LS20, and SN54S20 are characterized for operation over the full military range of -55°C to 125°C. The SN7420, SN74LS20, and SN74S20 are characterized for operation from 0°C to 70°C.

**FUNCTION TABLE (each gate)**

INPUTS				OUTPUT
A	B	C	D	Y
H	H	H	H	L
L	X	X	X	H
X	L	X	X	H
X	X	L	X	H
X	X	X	L	H

**logic symbol†**

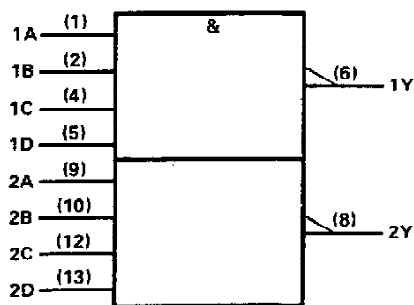

†This symbol is in accordance with ANSI/IEEE Std. 91-1984 and IEC Publication 617-12.

Pin numbers shown are for D, J, N, and W packages.

SN5420 . . . J PACKAGE  
SN54LS20, SN54S20 . . . J OR W PACKAGE  
SN7420 . . . N PACKAGE  
SN74LS20, SN74S20 . . . D OR N PACKAGE  
(TOP VIEW)

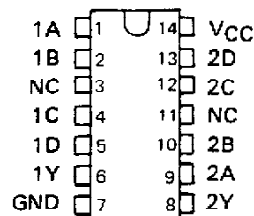

SN5420 . . . W PACKAGE  
(TOP VIEW)

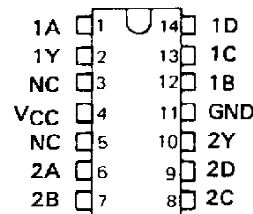

SN54LS20, SN54S20 . . . FK PACKAGE  
(TOP VIEW)

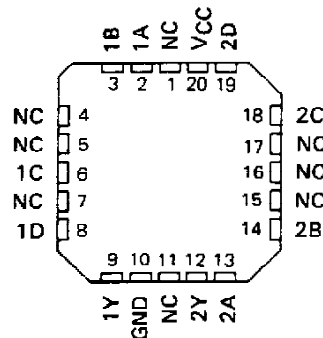

NC - No internal connection

**logic diagram**

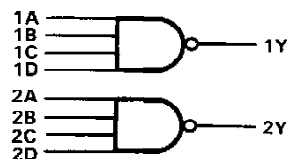

positive logic  $Y = \overline{A \cdot B \cdot C \cdot D}$  or  $Y = \overline{A} + \overline{B} + \overline{C} + \overline{D}$

PRODUCTION DATA documents contain information current as of publication date. Products conform to specifications per the terms of Texas Instruments standard warranty. Production processing does not necessarily include testing of all parameters.



**SN5420, SN54LS20, SN54S20,  
SN7420, SN74LS20, SN74S20  
DUAL 4-INPUT POSITIVE-NAND GATES**

schematics (each gate)

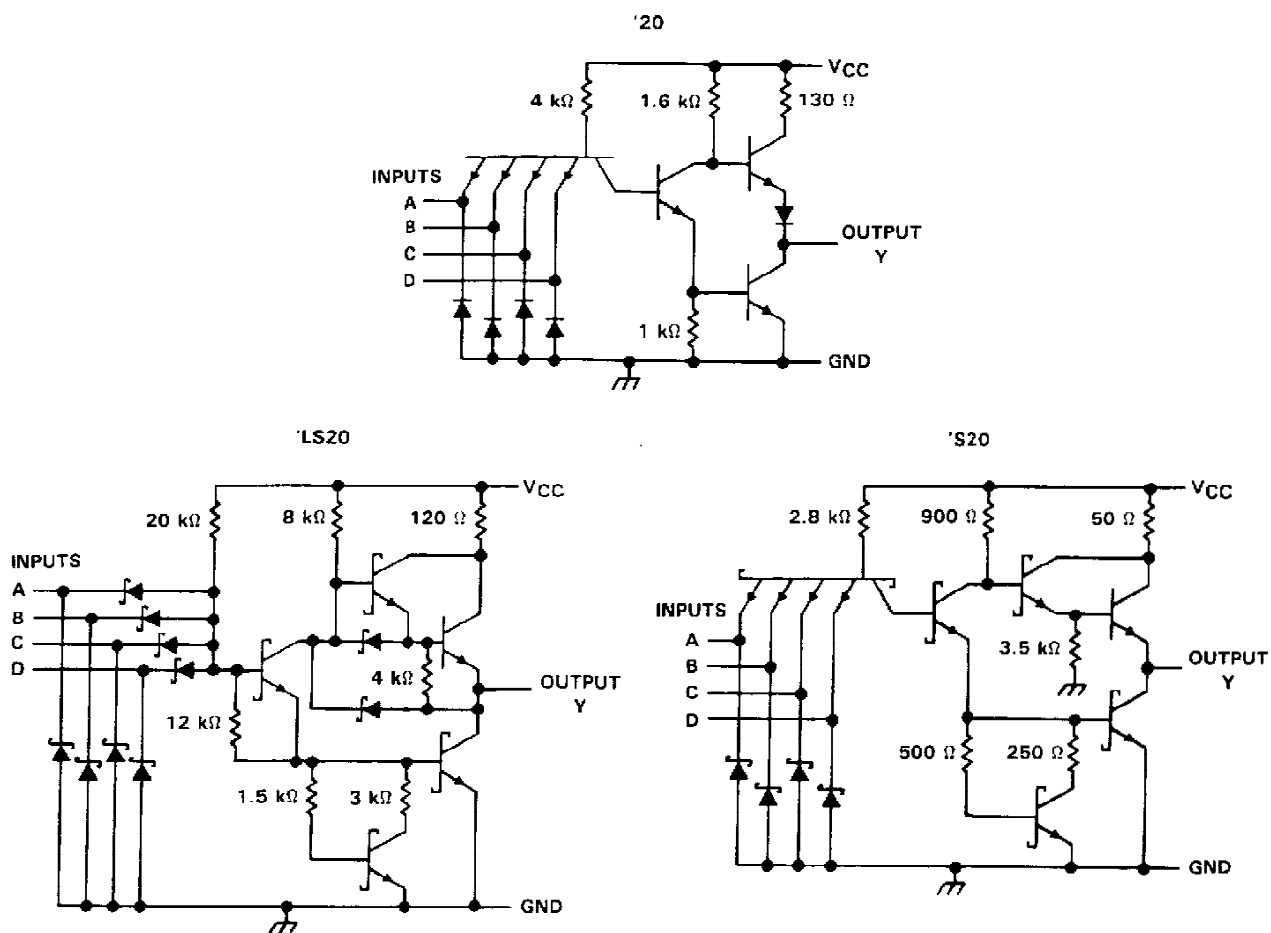

Resistor values shown are nominal.

**absolute maximum ratings over operating free-air temperature range (unless otherwise noted)**

Supply voltage, V <sub>CC</sub> (see Note 1) .....	7 V
Input voltage: '20, 'S20 .....	5.5 V
'LS20 .....	7 V
Operating free-air temperature range: SN54' .....	-55°C to 125°C
SN74' .....	0°C to 70°C
Storage temperature range .....	-65°C to 150°C

NOTE 1: Voltage values are with respect to network ground terminals.



POST OFFICE BOX 655012 • DALLAS, TEXAS 75265

**SN5420, SN7420**  
**DUAL 4-INPUT POSITIVE-NAND GATES**

**recommended operating conditions**

	SN5420			SN7420			UNIT
	MIN	NOM	MAX	MIN	NOM	MAX	
V <sub>CC</sub> Supply voltage	4.5	5	5.5	4.75	5	5.25	V
V <sub>IH</sub> High-level input voltage	2			2			V
V <sub>IL</sub> Low-level input voltage			0.8			0.8	V
I <sub>OH</sub> High-level output current			-0.4			-0.4	mA
I <sub>OL</sub> Low-level output current			16			16	mA
T <sub>A</sub> Operating free-air temperature	-55		125	0		70	°C

**electrical characteristics over recommended operating free-air temperature range (unless otherwise noted)**

PARAMETER	TEST CONDITIONS †	SN5420			SN7420			UNIT
		MIN	TYP ‡	MAX	MIN	TYP ‡	MAX	
V <sub>IK</sub>	V <sub>CC</sub> = MIN, I <sub>I</sub> = -12 mA			-1.5			-1.5	V
V <sub>OH</sub>	V <sub>CC</sub> = MIN, V <sub>IL</sub> = 0.8 V, I <sub>OH</sub> = -0.4 mA	2.4	3.4		2.4	3.4		V
V <sub>OL</sub>	V <sub>CC</sub> = MIN, V <sub>IH</sub> = 2 V, I <sub>OL</sub> = 16 mA		0.2	0.4		0.2	0.4	V
I <sub>I</sub>	V <sub>CC</sub> = MAX, V <sub>I</sub> = 5.5 V			1			1	mA
I <sub>IH</sub>	V <sub>CC</sub> = MAX, V <sub>I</sub> = 2.4 V			40			40	µA
I <sub>IL</sub>	V <sub>CC</sub> = MAX, V <sub>I</sub> = 0.4 V			-1.6			-1.6	mA
I <sub>OS</sub> §	V <sub>CC</sub> = MAX	-20		-55	-18		-55	mA
I <sub>CCH</sub>	V <sub>CC</sub> = MAX, V <sub>I</sub> = 0 V		2	4		2	4	mA
I <sub>CCL</sub>	V <sub>CC</sub> = MAX, V <sub>I</sub> = 4.5 V		6	11		6	11	mA

† For conditions shown as MIN or MAX, use the appropriate value specified under recommended operating conditions.

‡ All typical values are at V<sub>CC</sub> = 5 V, T<sub>A</sub> = 25°C.

§ Not more than one output should be shorted at a time.

**switching characteristics, V<sub>CC</sub> = 5 V, T<sub>A</sub> = 25°C (see note 2)**

PARAMETER	FROM (INPUT)	TO (OUTPUT)	TEST CONDITIONS	MIN	TYP	MAX	UNIT
t <sub>PLH</sub>	Any	Y	R <sub>L</sub> = 400 Ω, C <sub>L</sub> = 15 pF		12	22	ns
t <sub>PHL</sub>					8	15	ns

NOTE 2: Load circuits and voltage waveforms are shown in Section 1.



# SN54LS20, SN74LS20 DUAL 4-INPUT POSITIVE-NAND GATES

## recommended operating conditions

	SN54LS20			SN74LS20			UNIT
	MIN	NOM	MAX	MIN	NOM	MAX	
V <sub>CC</sub> Supply voltage	4.5	5	5.5	4.75	5	5.25	V
V <sub>IH</sub> High-level input voltage	2			2			V
V <sub>IL</sub> Low-level input voltage			0.7			0.8	V
I <sub>OH</sub> High-level output current			-0.4			-0.4	mA
I <sub>OL</sub> Low-level output current			4			8	mA
T <sub>A</sub> Operating free-air temperature	-55		125	0		70	°C

## electrical characteristics over recommended operating free-air temperature range (unless otherwise noted)

PARAMETER	TEST CONDITIONS †	SN54LS20			SN74LS20			UNIT
		MIN	TYP ‡	MAX	MIN	TYP ‡	MAX	
V <sub>IK</sub>	V <sub>CC</sub> = MIN, I <sub>I</sub> = -18 mA			-1.5			-1.5	V
V <sub>OH</sub>	V <sub>CC</sub> = MIN, V <sub>IL</sub> = MAX, I <sub>OH</sub> = -0.4 mA	2.5	3.4		2.7	3.4		V
V <sub>OL</sub>	V <sub>CC</sub> = MIN, V <sub>IH</sub> = 2 V, I <sub>OL</sub> = 4 mA		0.25	0.4			0.4	V
	V <sub>CC</sub> = MIN, V <sub>IH</sub> = 2 V, I <sub>OL</sub> = 8 mA				0.25	0.5		
I <sub>I</sub>	V <sub>CC</sub> = MAX, V <sub>I</sub> = 7 V			0.1			0.1	mA
I <sub>IH</sub>	V <sub>CC</sub> = MAX, V <sub>I</sub> = 2.7 V			20			20	μA
I <sub>IL</sub>	V <sub>CC</sub> = MAX, V <sub>I</sub> = 0.4 V			-0.4			-0.4	mA
I <sub>OS</sub> §	V <sub>CC</sub> = MAX	-20		-100	-20		-100	mA
I <sub>CCH</sub>	V <sub>CC</sub> = MAX, V <sub>I</sub> = 0 V		0.4	0.8		0.4	0.8	mA
I <sub>CCL</sub>	V <sub>CC</sub> = MAX, V <sub>I</sub> = 4.5 V		1.2	2.2		1.2	2.2	mA

† For conditions shown as MIN or MAX, use the appropriate value specified under recommended operating conditions.

‡ All typical values are at V<sub>CC</sub> = 5 V, T<sub>A</sub> = 25°C.

§ Not more than one output should be shorted at a time, and the duration of the short-circuit should not exceed one second.

## switching characteristics, V<sub>CC</sub> = 5 V, T<sub>A</sub> = 25°C (see note 2)

PARAMETER	FROM (INPUT)	TO (OUTPUT)	TEST CONDITIONS	MIN	TYP	MAX	UNIT
t <sub>PLH</sub>	Any	Y	R <sub>L</sub> = 2 kΩ, C <sub>L</sub> = 15 pF		9	15	ns
t <sub>PHL</sub>					10	15	ns

NOTE 2: Load circuits and voltage waveforms are shown in Section 1.

  
TEXAS  
INSTRUMENTS

POST OFFICE BOX 655012 • DALLAS, TEXAS 75265

## SN54S20, SN74S20 DUAL 4-INPUT POSITIVE-NAND GATES

### recommended operating conditions

	SN54S20			SN74S20			UNIT
	MIN	NOM	MAX	MIN	NOM	MAX	
$V_{CC}$ Supply voltage	4.5	5	5.5	4.75	5	5.25	V
$V_{IH}$ High-level input voltage	2			2			V
$V_{IL}$ Low-level input voltage			0.8			0.8	V
$I_{OH}$ High-level output current			-1			-1	mA
$I_{OL}$ Low-level output current			20			20	mA
$T_A$ Operating free-air temperature	-55		125	0		70	°C

### electrical characteristics over recommended operating free-air temperature range (unless otherwise noted)

PARAMETER	TEST CONDITIONS †	SN54S20			SN74S20			UNIT
		MIN	TYP ‡	MAX	MIN	TYP ‡	MAX	
$V_{IK}$	$V_{CC} = \text{MIN}$ , $I_I = -18 \text{ mA}$			-1.2			-1.2	V
$V_{OH}$	$V_{CC} = \text{MIN}$ , $V_{IL} = 0.8 \text{ V}$ , $I_{OH} = -1 \text{ mA}$	2.5	3.4		2.7	3.4		V
$V_{OL}$	$V_{CC} = \text{MIN}$ , $V_{IH} = 2 \text{ V}$ , $I_{OL} = 20 \text{ mA}$			0.5			0.5	V
$I_I$	$V_{CC} = \text{MAX}$ , $V_I = 5.5 \text{ V}$			1			1	mA
$I_{IH}$	$V_{CC} = \text{MAX}$ , $V_I = 2.7 \text{ V}$			50			50	μA
$I_{IL}$	$V_{CC} = \text{MAX}$ , $V_I = 0.5 \text{ V}$			-2			-2	mA
$I_{OS} §$	$V_{CC} = \text{MAX}$	-40		-100	-40		-100	mA
$I_{CCH}$	$V_{CC} = \text{MAX}$ , $V_I = 0 \text{ V}$		5	8		5	8	mA
$I_{CCL}$	$V_{CC} = \text{MAX}$ , $V_I = 4.5 \text{ V}$		10	18		10	18	mA

† For conditions shown as MIN or MAX, use the appropriate value specified under recommended operating conditions.

‡ All typical values are at  $V_{CC} = 5 \text{ V}$ ,  $T_A = 25^\circ\text{C}$ .

§ Not more than one output should be shorted at a time, and the duration of the short-circuit should not exceed one second.

### switching characteristics, $V_{CC} = 5 \text{ V}$ , $T_A = 25^\circ\text{C}$ (see note 2)

PARAMETER	FROM (INPUT)	TO (OUTPUT)	TEST CONDITIONS	MIN	TYP	MAX	UNIT
$t_{PLH}$	A, B, C or D	Y	$R_L = 280 \Omega$ , $C_L = 15 \text{ pF}$		3	4.5	ns
$t_{PHL}$					3	5	ns
$t_{PLH}$			$R_L = 280 \Omega$ , $C_L = 50 \text{ pF}$		4.5		ns
$t_{PHL}$					5		ns

NOTE 2: Load circuits and voltage waveforms are shown in Section 1.

  
**TEXAS  
INSTRUMENTS**

POST OFFICE BOX 655012 • DALLAS, TEXAS 75265

**PACKAGING INFORMATION**

Orderable Device	Status (1)	Package Type	Package Drawing	Pins	Package Qty	Eco Plan (2)	Lead/Ball Finish (6)	MSL Peak Temp (3)	Op Temp (°C)	Device Marking (4/5)	Samples
JM38510/07006BCA	ACTIVE	CDIP	J	14	1	TBD	A42	N / A for Pkg Type	-55 to 125	JM38510/ 07006BCA	<a href="#">Samples</a>
JM38510/07006BDA	ACTIVE	CFP	W	14	1	TBD	A42	N / A for Pkg Type	-55 to 125	JM38510/ 07006BDA	<a href="#">Samples</a>
JM38510/07006BDA	ACTIVE	CFP	W	14	1	TBD	A42	N / A for Pkg Type	-55 to 125	JM38510/ 07006BDA	<a href="#">Samples</a>
JM38510/30007B2A	ACTIVE	LCCC	FK	20	1	TBD	POST-PLATE	N / A for Pkg Type	-55 to 125	JM38510/ 30007B2A	<a href="#">Samples</a>
JM38510/30007B2A	ACTIVE	LCCC	FK	20	1	TBD	POST-PLATE	N / A for Pkg Type	-55 to 125	JM38510/ 30007B2A	<a href="#">Samples</a>
JM38510/30007BCA	ACTIVE	CDIP	J	14	1	TBD	A42	N / A for Pkg Type	-55 to 125	JM38510/ 30007BCA	<a href="#">Samples</a>
JM38510/30007BCA	ACTIVE	CDIP	J	14	1	TBD	A42	N / A for Pkg Type	-55 to 125	JM38510/ 30007BCA	<a href="#">Samples</a>
JM38510/30007BDA	ACTIVE	CFP	W	14	1	TBD	A42	N / A for Pkg Type	-55 to 125	JM38510/ 30007BDA	<a href="#">Samples</a>
JM38510/30007BDA	ACTIVE	CFP	W	14	1	TBD	A42	N / A for Pkg Type	-55 to 125	JM38510/ 30007BDA	<a href="#">Samples</a>
JM38510/30007SCA	ACTIVE	CDIP	J	14	25	TBD	A42	N / A for Pkg Type	-55 to 125	JM38510/ 30007SCA	<a href="#">Samples</a>
JM38510/30007SCA	ACTIVE	CDIP	J	14	25	TBD	A42	N / A for Pkg Type	-55 to 125	JM38510/ 30007SCA	<a href="#">Samples</a>
JM38510/30007SDA	ACTIVE	CFP	W	14	25	TBD	A42	N / A for Pkg Type	-55 to 125	JM38510/ 30007SDA	<a href="#">Samples</a>
JM38510/30007SDA	ACTIVE	CFP	W	14	25	TBD	A42	N / A for Pkg Type	-55 to 125	JM38510/ 30007SDA	<a href="#">Samples</a>
M38510/07006BCA	ACTIVE	CDIP	J	14	1	TBD	A42	N / A for Pkg Type	-55 to 125	JM38510/ 07006BCA	<a href="#">Samples</a>
M38510/07006BCA	ACTIVE	CDIP	J	14	1	TBD	A42	N / A for Pkg Type	-55 to 125	JM38510/ 07006BCA	<a href="#">Samples</a>
M38510/07006BDA	ACTIVE	CFP	W	14	1	TBD	A42	N / A for Pkg Type	-55 to 125	JM38510/ 07006BDA	<a href="#">Samples</a>
M38510/07006BDA	ACTIVE	CFP	W	14	1	TBD	A42	N / A for Pkg Type	-55 to 125	JM38510/ 07006BDA	<a href="#">Samples</a>

Orderable Device	Status (1)	Package Type	Package Drawing	Pins	Package Qty	Eco Plan (2)	Lead/Ball Finish (6)	MSL Peak Temp (3)	Op Temp (°C)	Device Marking (4/5)	Samples
M38510/30007B2A	ACTIVE	LCCC	FK	20	1	TBD	POST-PLATE	N / A for Pkg Type	-55 to 125	JM38510/ 30007B2A	<a href="#">Samples</a>
M38510/30007B2A	ACTIVE	LCCC	FK	20	1	TBD	POST-PLATE	N / A for Pkg Type	-55 to 125	JM38510/ 30007B2A	<a href="#">Samples</a>
M38510/30007BCA	ACTIVE	CDIP	J	14	1	TBD	A42	N / A for Pkg Type	-55 to 125	JM38510/ 30007BCA	<a href="#">Samples</a>
M38510/30007BCA	ACTIVE	CDIP	J	14	1	TBD	A42	N / A for Pkg Type	-55 to 125	JM38510/ 30007BCA	<a href="#">Samples</a>
M38510/30007BDA	ACTIVE	CFP	W	14	1	TBD	A42	N / A for Pkg Type	-55 to 125	JM38510/ 30007BDA	<a href="#">Samples</a>
M38510/30007BDA	ACTIVE	CFP	W	14	1	TBD	A42	N / A for Pkg Type	-55 to 125	JM38510/ 30007BDA	<a href="#">Samples</a>
M38510/30007SCA	ACTIVE	CDIP	J	14	25	TBD	A42	N / A for Pkg Type	-55 to 125	JM38510/ 30007SCA	<a href="#">Samples</a>
M38510/30007SCA	ACTIVE	CDIP	J	14	25	TBD	A42	N / A for Pkg Type	-55 to 125	JM38510/ 30007SCA	<a href="#">Samples</a>
M38510/30007SDA	ACTIVE	CFP	W	14	25	TBD	A42	N / A for Pkg Type	-55 to 125	JM38510/ 30007SDA	<a href="#">Samples</a>
M38510/30007SDA	ACTIVE	CFP	W	14	25	TBD	A42	N / A for Pkg Type	-55 to 125	JM38510/ 30007SDA	<a href="#">Samples</a>
SN5420J	OBSOLETE	CDIP	J	14		TBD	Call TI	Call TI	-55 to 125		
SN5420J	OBSOLETE	CDIP	J	14		TBD	Call TI	Call TI	-55 to 125		
SN54LS20J	ACTIVE	CDIP	J	14	1	TBD	A42	N / A for Pkg Type	-55 to 125	SN54LS20J	<a href="#">Samples</a>
SN54LS20J	ACTIVE	CDIP	J	14	1	TBD	A42	N / A for Pkg Type	-55 to 125	SN54LS20J	<a href="#">Samples</a>
SN54S20J	ACTIVE	CDIP	J	14	1	TBD	A42	N / A for Pkg Type	-55 to 125	SN54S20J	<a href="#">Samples</a>
SN54S20J	ACTIVE	CDIP	J	14	1	TBD	A42	N / A for Pkg Type	-55 to 125	SN54S20J	<a href="#">Samples</a>
SN7420N	OBSOLETE	PDIP	N	14		TBD	Call TI	Call TI	0 to 70		
SN7420N	OBSOLETE	PDIP	N	14		TBD	Call TI	Call TI	0 to 70		
SN74LS20-W	ACTIVE	WAFERSALE	YS	0		TBD	Call TI	Call TI			<a href="#">Samples</a>
SN74LS20-W	ACTIVE	WAFERSALE	YS	0		TBD	Call TI	Call TI			<a href="#">Samples</a>
SN74LS20D	ACTIVE	SOIC	D	14	50	Green (RoHS & no Sb/Br)	CU NIPDAU	Level-1-260C-UNLIM	0 to 70	LS20	<a href="#">Samples</a>

Orderable Device	Status (1)	Package Type	Package Drawing	Pins	Package Qty	Eco Plan (2)	Lead/Ball Finish (6)	MSL Peak Temp (3)	Op Temp (°C)	Device Marking (4/5)	Samples
SN74LS20D	ACTIVE	SOIC	D	14	50	Green (RoHS & no Sb/Br)	CU NIPDAU	Level-1-260C-UNLIM	0 to 70	LS20	<a href="#">Samples</a>
SN74LS20DE4	ACTIVE	SOIC	D	14		TBD	Call TI	Call TI	0 to 70		<a href="#">Samples</a>
SN74LS20DE4	ACTIVE	SOIC	D	14		TBD	Call TI	Call TI	0 to 70		<a href="#">Samples</a>
SN74LS20DG4	ACTIVE	SOIC	D	14	50	Green (RoHS & no Sb/Br)	CU NIPDAU	Level-1-260C-UNLIM	0 to 70	LS20	<a href="#">Samples</a>
SN74LS20DG4	ACTIVE	SOIC	D	14	50	Green (RoHS & no Sb/Br)	CU NIPDAU	Level-1-260C-UNLIM	0 to 70	LS20	<a href="#">Samples</a>
SN74LS20DR	ACTIVE	SOIC	D	14	2500	Green (RoHS & no Sb/Br)	CU NIPDAU	Level-1-260C-UNLIM	0 to 70	LS20	<a href="#">Samples</a>
SN74LS20DR	ACTIVE	SOIC	D	14	2500	Green (RoHS & no Sb/Br)	CU NIPDAU	Level-1-260C-UNLIM	0 to 70	LS20	<a href="#">Samples</a>
SN74LS20DRE4	ACTIVE	SOIC	D	14		TBD	Call TI	Call TI	0 to 70		<a href="#">Samples</a>
SN74LS20DRE4	ACTIVE	SOIC	D	14		TBD	Call TI	Call TI	0 to 70		<a href="#">Samples</a>
SN74LS20DRG4	ACTIVE	SOIC	D	14		TBD	Call TI	Call TI	0 to 70		<a href="#">Samples</a>
SN74LS20DRG4	ACTIVE	SOIC	D	14		TBD	Call TI	Call TI	0 to 70		<a href="#">Samples</a>
SN74LS20J	OBSOLETE	CDIP	J	14		TBD	Call TI	Call TI	0 to 70		
SN74LS20J	OBSOLETE	CDIP	J	14		TBD	Call TI	Call TI	0 to 70		
SN74LS20N	ACTIVE	PDIP	N	14	25	Pb-Free (RoHS)	CU NIPDAU	N / A for Pkg Type	0 to 70	SN74LS20N	<a href="#">Samples</a>
SN74LS20N	ACTIVE	PDIP	N	14	25	Pb-Free (RoHS)	CU NIPDAU	N / A for Pkg Type	0 to 70	SN74LS20N	<a href="#">Samples</a>
SN74LS20N3	OBSOLETE	PDIP	N	14		TBD	Call TI	Call TI	0 to 70		
SN74LS20N3	OBSOLETE	PDIP	N	14		TBD	Call TI	Call TI	0 to 70		
SN74LS20NE4	ACTIVE	PDIP	N	14	25	Pb-Free (RoHS)	CU NIPDAU	N / A for Pkg Type	0 to 70	SN74LS20N	<a href="#">Samples</a>
SN74LS20NE4	ACTIVE	PDIP	N	14	25	Pb-Free (RoHS)	CU NIPDAU	N / A for Pkg Type	0 to 70	SN74LS20N	<a href="#">Samples</a>
SN74LS20NSR	ACTIVE	SO	NS	14	2000	Green (RoHS & no Sb/Br)	CU NIPDAU	Level-1-260C-UNLIM	0 to 70	74LS20	<a href="#">Samples</a>
SN74LS20NSR	ACTIVE	SO	NS	14	2000	Green (RoHS & no Sb/Br)	CU NIPDAU	Level-1-260C-UNLIM	0 to 70	74LS20	<a href="#">Samples</a>



Orderable Device	Status (1)	Package Type	Package Drawing	Pins	Package Qty	Eco Plan (2)	Lead/Ball Finish (6)	MSL Peak Temp (3)	Op Temp (°C)	Device Marking (4/5)	Samples
SN74LS20NSRE4	ACTIVE	SO	NS	14		TBD	Call TI	Call TI	0 to 70		<a href="#">Samples</a>
SN74LS20NSRE4	ACTIVE	SO	NS	14		TBD	Call TI	Call TI	0 to 70		<a href="#">Samples</a>
SN74LS20NSRG4	ACTIVE	SO	NS	14		TBD	Call TI	Call TI	0 to 70		<a href="#">Samples</a>
SN74LS20NSRG4	ACTIVE	SO	NS	14		TBD	Call TI	Call TI	0 to 70		<a href="#">Samples</a>
SN74S20D	ACTIVE	SOIC	D	14	50	Green (RoHS & no Sb/Br)	CU NIPDAU	Level-1-260C-UNLIM	0 to 70	S20	<a href="#">Samples</a>
SN74S20D	ACTIVE	SOIC	D	14	50	Green (RoHS & no Sb/Br)	CU NIPDAU	Level-1-260C-UNLIM	0 to 70	S20	<a href="#">Samples</a>
SN74S20DR	OBSOLETE	SOIC	D	0		TBD	Call TI	Call TI	0 to 70		
SN74S20DR	OBSOLETE	SOIC	D	0		TBD	Call TI	Call TI	0 to 70		
SN74S20N	ACTIVE	PDIP	N	14	25	Pb-Free (RoHS)	CU NIPDAU	N / A for Pkg Type	0 to 70	SN74S20N	<a href="#">Samples</a>
SN74S20N	ACTIVE	PDIP	N	14	25	Pb-Free (RoHS)	CU NIPDAU	N / A for Pkg Type	0 to 70	SN74S20N	<a href="#">Samples</a>
SN74S20N3	OBSOLETE	PDIP	N	14		TBD	Call TI	Call TI	0 to 70		
SN74S20N3	OBSOLETE	PDIP	N	14		TBD	Call TI	Call TI	0 to 70		
SN74S20NE4	ACTIVE	PDIP	N	14	25	Pb-Free (RoHS)	CU NIPDAU	N / A for Pkg Type	0 to 70	SN74S20N	<a href="#">Samples</a>
SN74S20NE4	ACTIVE	PDIP	N	14	25	Pb-Free (RoHS)	CU NIPDAU	N / A for Pkg Type	0 to 70	SN74S20N	<a href="#">Samples</a>
SNJ5420J	OBSOLETE	CDIP	J	14		TBD	Call TI	Call TI	-55 to 125		
SNJ5420J	OBSOLETE	CDIP	J	14		TBD	Call TI	Call TI	-55 to 125		
SNJ5420W	OBSOLETE	CFP	W	14		TBD	Call TI	Call TI	-55 to 125		
SNJ5420W	OBSOLETE	CFP	W	14		TBD	Call TI	Call TI	-55 to 125		
SNJ5420WA	OBSOLETE	CFP	WA	14		TBD	Call TI	Call TI	-55 to 125		
SNJ5420WA	OBSOLETE	CFP	WA	14		TBD	Call TI	Call TI	-55 to 125		
SNJ54LS20FK	ACTIVE	LCCC	FK	20	1	TBD	POST-PLATE	N / A for Pkg Type	-55 to 125	SNJ54LS 20FK	<a href="#">Samples</a>
SNJ54LS20FK	ACTIVE	LCCC	FK	20	1	TBD	POST-PLATE	N / A for Pkg Type	-55 to 125	SNJ54LS 20FK	<a href="#">Samples</a>
SNJ54LS20J	ACTIVE	CDIP	J	14	1	TBD	A42	N / A for Pkg Type	-55 to 125	SNJ54LS20J	<a href="#">Samples</a>

Orderable Device	Status (1)	Package Type	Package Drawing	Pins	Package Qty	Eco Plan (2)	Lead/Ball Finish (6)	MSL Peak Temp (3)	Op Temp (°C)	Device Marking (4/5)	Samples
SNJ54LS20J	ACTIVE	CDIP	J	14	1	TBD	A42	N / A for Pkg Type	-55 to 125	SNJ54LS20J	<a href="#">Samples</a>
SNJ54LS20W	ACTIVE	CFP	W	14	1	TBD	A42	N / A for Pkg Type	-55 to 125	SNJ54LS20W	<a href="#">Samples</a>
SNJ54LS20W	ACTIVE	CFP	W	14	1	TBD	A42	N / A for Pkg Type	-55 to 125	SNJ54LS20W	<a href="#">Samples</a>
SNJ54S20FK	ACTIVE	LCCC	FK	20	1	TBD	POST-PLATE	N / A for Pkg Type	-55 to 125	SNJ54S 20FK	<a href="#">Samples</a>
SNJ54S20FK	ACTIVE	LCCC	FK	20	1	TBD	POST-PLATE	N / A for Pkg Type	-55 to 125	SNJ54S 20FK	<a href="#">Samples</a>
SNJ54S20J	ACTIVE	CDIP	J	14	1	TBD	A42	N / A for Pkg Type	-55 to 125	SNJ54S20J	<a href="#">Samples</a>
SNJ54S20J	ACTIVE	CDIP	J	14	1	TBD	A42	N / A for Pkg Type	-55 to 125	SNJ54S20J	<a href="#">Samples</a>
SNJ54S20W	ACTIVE	CFP	W	14	1	TBD	A42	N / A for Pkg Type	-55 to 125	SNJ54S20W	<a href="#">Samples</a>
SNJ54S20W	ACTIVE	CFP	W	14	1	TBD	A42	N / A for Pkg Type	-55 to 125	SNJ54S20W	<a href="#">Samples</a>

(1) The marketing status values are defined as follows:

**ACTIVE:** Product device recommended for new designs.

**LIFEBUY:** TI has announced that the device will be discontinued, and a lifetime-buy period is in effect.

**NRND:** Not recommended for new designs. Device is in production to support existing customers, but TI does not recommend using this part in a new design.

**PREVIEW:** Device has been announced but is not in production. Samples may or may not be available.

**OBSELETE:** TI has discontinued the production of the device.

(2) Eco Plan - The planned eco-friendly classification: Pb-Free (RoHS), Pb-Free (RoHS Exempt), or Green (RoHS & no Sb/Br) - please check <http://www.ti.com/productcontent> for the latest availability information and additional product content details.

**TBD:** The Pb-Free/Green conversion plan has not been defined.

**Pb-Free (RoHS):** TI's terms "Lead-Free" or "Pb-Free" mean semiconductor products that are compatible with the current RoHS requirements for all 6 substances, including the requirement that lead not exceed 0.1% by weight in homogeneous materials. Where designed to be soldered at high temperatures, TI Pb-Free products are suitable for use in specified lead-free processes.

**Pb-Free (RoHS Exempt):** This component has a RoHS exemption for either 1) lead-based flip-chip solder bumps used between the die and package, or 2) lead-based die adhesive used between the die and leadframe. The component is otherwise considered Pb-Free (RoHS compatible) as defined above.

**Green (RoHS & no Sb/Br):** TI defines "Green" to mean Pb-Free (RoHS compatible), and free of Bromine (Br) and Antimony (Sb) based flame retardants (Br or Sb do not exceed 0.1% by weight in homogeneous material)

(3) MSL, Peak Temp. - The Moisture Sensitivity Level rating according to the JEDEC industry standard classifications, and peak solder temperature.

(4) There may be additional marking, which relates to the logo, the lot trace code information, or the environmental category on the device.

---

<sup>(5)</sup> Multiple Device Markings will be inside parentheses. Only one Device Marking contained in parentheses and separated by a "-" will appear on a device. If a line is indented then it is a continuation of the previous line and the two combined represent the entire Device Marking for that device.

<sup>(6)</sup> Lead/Ball Finish - Orderable Devices may have multiple material finish options. Finish options are separated by a vertical ruled line. Lead/Ball Finish values may wrap to two lines if the finish value exceeds the maximum column width.

**Important Information and Disclaimer:**The information provided on this page represents TI's knowledge and belief as of the date that it is provided. TI bases its knowledge and belief on information provided by third parties, and makes no representation or warranty as to the accuracy of such information. Efforts are underway to better integrate information from third parties. TI has taken and continues to take reasonable steps to provide representative and accurate information but may not have conducted destructive testing or chemical analysis on incoming materials and chemicals. TI and TI suppliers consider certain information to be proprietary, and thus CAS numbers and other limited information may not be available for release.

In no event shall TI's liability arising out of such information exceed the total purchase price of the TI part(s) at issue in this document sold by TI to Customer on an annual basis.

**OTHER QUALIFIED VERSIONS OF SN5420, SN54LS20, SN54LS20-SP, SN54S20, SN7420, SN74LS20, SN74S20 :**

- Catalog: [SN7420](#), [SN74LS20](#), [SN54LS20](#), [SN74S20](#)
- Military: [SN5420](#), [SN54LS20](#), [SN54S20](#)
- Space: [SN54LS20-SP](#)

NOTE: Qualified Version Definitions:

- Catalog - TI's standard catalog product
- Military - QML certified for Military and Defense Applications
- Space - Radiation tolerant, ceramic packaging and qualified for use in Space-based application

## TAPE AND REEL INFORMATION

### REEL DIMENSIONS



### TAPE DIMENSIONS



A0	Dimension designed to accommodate the component width
B0	Dimension designed to accommodate the component length
K0	Dimension designed to accommodate the component thickness
W	Overall width of the carrier tape
P1	Pitch between successive cavity centers

### TAPE AND REEL INFORMATION

\*All dimensions are nominal

Device	Package Type	Package Drawing	Pins	SPQ	Reel Diameter (mm)	Reel Width W1 (mm)	A0 (mm)	B0 (mm)	K0 (mm)	P1 (mm)	W (mm)	Pin1 Quadrant
SN74LS20DR	SOIC	D	14	2500	330.0	16.4	6.5	9.0	2.1	8.0	16.0	Q1
SN74LS20NSR	SO	NS	14	2000	330.0	16.4	8.2	10.5	2.5	12.0	16.0	Q1

**TAPE AND REEL BOX DIMENSIONS**

\*All dimensions are nominal

Device	Package Type	Package Drawing	Pins	SPQ	Length (mm)	Width (mm)	Height (mm)
SN74LS20DR	SOIC	D	14	2500	367.0	367.0	38.0
SN74LS20NSR	SO	NS	14	2000	367.0	367.0	38.0

J (R-GDIP-T\*\*)

14 LEADS SHOWN

CERAMIC DUAL IN-LINE PACKAGE



DIM \ PINS **	14	16	18	20
A	0.300 (7,62) BSC	0.300 (7,62) BSC	0.300 (7,62) BSC	0.300 (7,62) BSC
B MAX	0.785 (19,94)	.840 (21,34)	0.960 (24,38)	1.060 (26,92)
B MIN	—	—	—	—
C MAX	0.300 (7,62)	0.300 (7,62)	0.310 (7,87)	0.300 (7,62)
C MIN	0.245 (6,22)	0.245 (6,22)	0.220 (5,59)	0.245 (6,22)



4040083/F 03/03

- NOTES:
- All linear dimensions are in inches (millimeters).
  - This drawing is subject to change without notice.
  - This package is hermetically sealed with a ceramic lid using glass frit.
  - Index point is provided on cap for terminal identification only on press ceramic glass frit seal only.
  - Falls within MIL STD 1835 GDIP1-T14, GDIP1-T16, GDIP1-T18 and GDIP1-T20.

W (R-GDFP-F14)

CERAMIC DUAL FLATPACK



- NOTES:
- A. All linear dimensions are in inches (millimeters).
  - B. This drawing is subject to change without notice.
  - C. This package can be hermetically sealed with a ceramic lid using glass frit.
  - D. Index point is provided on cap for terminal identification only.
  - E. Falls within MIL STD 1835 GDFP1-F14

FK (S-CQCC-N\*\*)

LEADLESS CERAMIC CHIP CARRIER

28 TERMINAL SHOWN



NO. OF TERMINALS **	A		B	
	MIN	MAX	MIN	MAX
20	0.342 (8,69)	0.358 (9,09)	0.307 (7,80)	0.358 (9,09)
28	0.442 (11,23)	0.458 (11,63)	0.406 (10,31)	0.458 (11,63)
44	0.640 (16,26)	0.660 (16,76)	0.495 (12,58)	0.560 (14,22)
52	0.740 (18,78)	0.761 (19,32)	0.495 (12,58)	0.560 (14,22)
68	0.938 (23,83)	0.962 (24,43)	0.850 (21,6)	0.858 (21,8)
84	1.141 (28,99)	1.165 (29,59)	1.047 (26,6)	1.063 (27,0)



4040140/D 01/11

- NOTES:
- All linear dimensions are in inches (millimeters).
  - This drawing is subject to change without notice.
  - This package can be hermetically sealed with a metal lid.
  - Falls within JEDEC MS-004



N (R-PDIP-T\*\*)

PLASTIC DUAL-IN-LINE PACKAGE

16 PINS SHOWN





- NOTES:
- A. All linear dimensions are in inches (millimeters).
  - B. This drawing is subject to change without notice.
  - Falls within JEDEC MS-001, except 18 and 20 pin minimum body length (Dim A).
  - The 20 pin end lead shoulder width is a vendor option, either half or full width.

D (R-PDSO-G14)

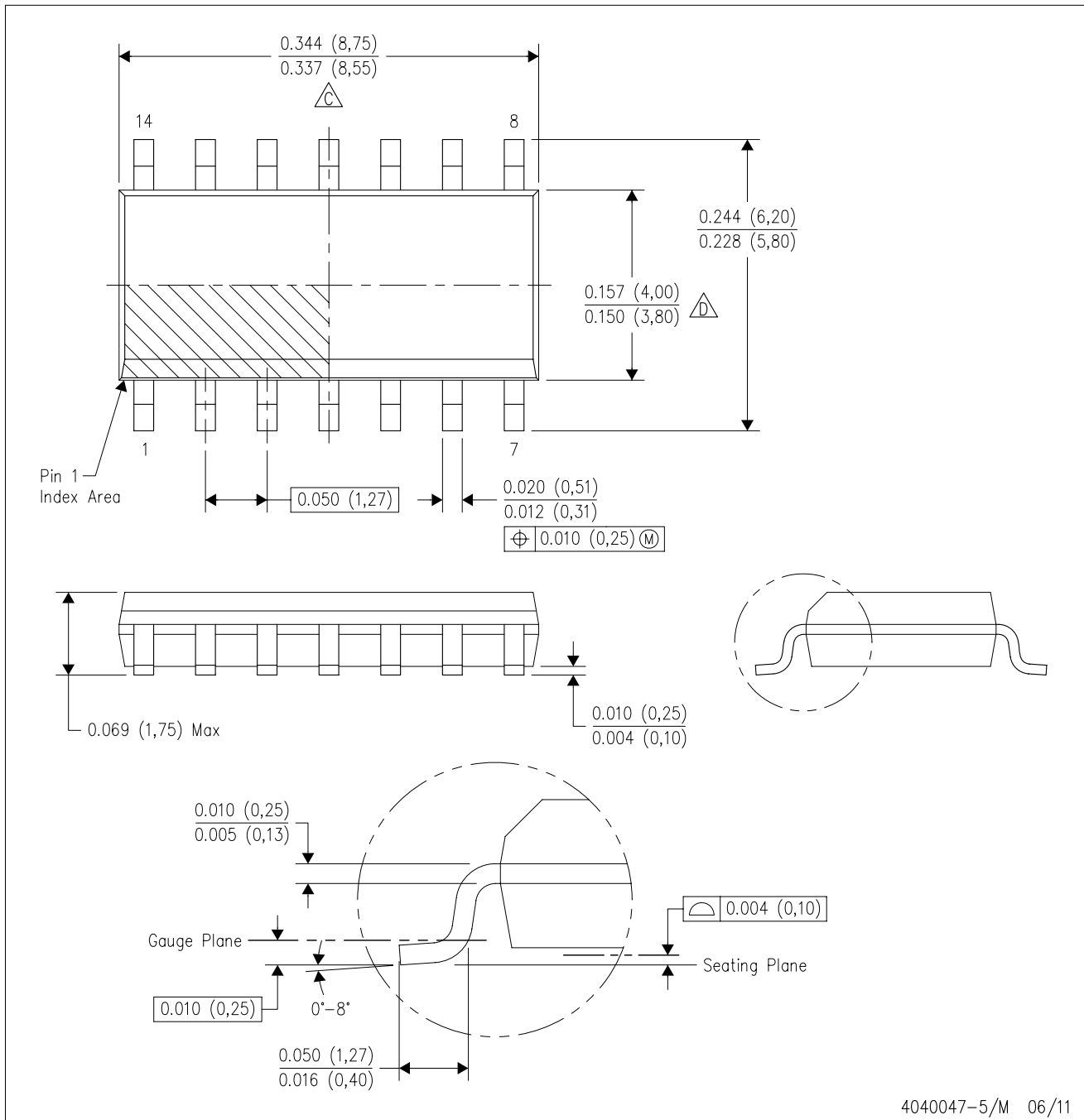
PLASTIC SMALL OUTLINE



- NOTES:
- A. All linear dimensions are in inches (millimeters).
  - B. This drawing is subject to change without notice.
  -  Body length does not include mold flash, protrusions, or gate burrs. Mold flash, protrusions, or gate burrs shall not exceed 0.006 (0,15) each side.
  -  Body width does not include interlead flash. Interlead flash shall not exceed 0.017 (0,43) each side.
  - E. Reference JEDEC MS-012 variation AB.

D (R-PDSO-G14)

PLASTIC SMALL OUTLINE



4211283-3/E 08/12

- NOTES:
- All linear dimensions are in millimeters.
  - This drawing is subject to change without notice.
  - Publication IPC-7351 is recommended for alternate designs.
  - Laser cutting apertures with trapezoidal walls and also rounding corners will offer better paste release. Customers should contact their board assembly site for stencil design recommendations. Refer to IPC-7525 for other stencil recommendations.
  - Customers should contact their board fabrication site for solder mask tolerances between and around signal pads.

## MECHANICAL DATA

NS (R-PDSO-G\*\*)

PLASTIC SMALL-OUTLINE PACKAGE

14-PINS SHOWN



- NOTES:
- A. All linear dimensions are in millimeters.
  - B. This drawing is subject to change without notice.
  - C. Body dimensions do not include mold flash or protrusion, not to exceed 0,15.