

SMPS MOSFET

IRF820A

HEXFET® Power MOSFET

Applications

- Switch Mode Power Supply (SMPS)
- Uninterruptable Power Supply
- High speed power switching

V_{DSS}	R_{DS(on)} max	I_D
500V	3.0Ω	2.5A

Benefits

- Low Gate Charge Q_g results in Simple Drive Requirement
- Improved Gate, Avalanche and dynamic dv/dt Ruggedness
- Fully Characterized Capacitance and Avalanche Voltage and Current
- Effective C_{OSS} specified (See AN 1001)

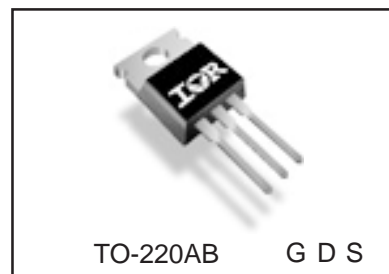

Absolute Maximum Ratings

	Parameter	Max.	Units
I _D @ T _C = 25°C	Continuous Drain Current, V _{GS} @ 10V	2.5	A
I _D @ T _C = 100°C	Continuous Drain Current, V _{GS} @ 10V	1.6	
I _{DM}	Pulsed Drain Current ①	10	
P _D @ T _C = 25°C	Power Dissipation	50	W
	Linear Derating Factor	0.4	W/°C
V _{GS}	Gate-to-Source Voltage	± 30	V
dv/dt	Peak Diode Recovery dv/dt ③	3.4	V/ns
T _J	Operating Junction and	-55 to + 150	°C
T _{STG}	Storage Temperature Range		
	Soldering Temperature, for 10 seconds	300 (1.6mm from case)	
	Mounting torque, 6-32 or M3 screw	10 lbf•in (1.1N•m)	

Typical SMPS Topologies:

- Two transistor Forward
- Half Bridge and Full Bridge

Notes ① through ⑤ are on page 8
www.irf.com

IRF820A

International
IR Rectifier

Static @ $T_J = 25^\circ\text{C}$ (unless otherwise specified)

	Parameter	Min.	Typ.	Max.	Units	Conditions
$V_{(BR)DSS}$	Drain-to-Source Breakdown Voltage	500	—	—	V	$V_{GS} = 0V, I_D = 250\mu A$
$\Delta V_{(BR)DSS}/\Delta T_J$	Breakdown Voltage Temp. Coefficient	—	0.60	—	V/°C	Reference to $25^\circ\text{C}, I_D = 1\text{mA}$
$R_{DS(on)}$	Static Drain-to-Source On-Resistance	—	—	3.0	Ω	$V_{GS} = 10V, I_D = 1.5A$ ④
$V_{GS(th)}$	Gate Threshold Voltage	2.0	—	4.5	V	$V_{DS} = V_{GS}, I_D = 250\mu A$
I_{DSS}	Drain-to-Source Leakage Current	—	—	25	μA	$V_{DS} = 500V, V_{GS} = 0V$
		—	—	250		$V_{DS} = 400V, V_{GS} = 0V, T_J = 125^\circ\text{C}$
I_{GSS}	Gate-to-Source Forward Leakage	—	—	100	nA	$V_{GS} = 30V$
	Gate-to-Source Reverse Leakage	—	—	-100		$V_{GS} = -30V$

Dynamic @ $T_J = 25^\circ\text{C}$ (unless otherwise specified)

	Parameter	Min.	Typ.	Max.	Units	Conditions
g_{fs}	Forward Transconductance	1.4	—	—	S	$V_{DS} = 50V, I_D = 1.5A$
Q_g	Total Gate Charge	—	—	17	nC	$I_D = 2.5A$
Q_{gs}	Gate-to-Source Charge	—	—	4.3		$V_{DS} = 400V$
Q_{gd}	Gate-to-Drain ("Miller") Charge	—	—	8.5		$V_{GS} = 10V$, See Fig. 6 and 13 ④
$t_{d(on)}$	Turn-On Delay Time	—	8.1	—	ns	$V_{DD} = 250V$
t_r	Rise Time	—	12	—		$I_D = 2.5A$
$t_{d(off)}$	Turn-Off Delay Time	—	16	—		$R_G = 21\Omega$
t_f	Fall Time	—	13	—		$R_D = 97\Omega$, See Fig. 10 ④
C_{iss}	Input Capacitance	—	340	—	pF	$V_{GS} = 0V$
C_{oss}	Output Capacitance	—	53	—		$V_{DS} = 25V$
C_{riss}	Reverse Transfer Capacitance	—	2.7	—		$f = 1.0\text{MHz}$, See Fig. 5
C_{oss}	Output Capacitance	—	490	—		$V_{GS} = 0V, V_{DS} = 1.0V, f = 1.0\text{MHz}$
C_{oss}	Output Capacitance	—	15	—		$V_{GS} = 0V, V_{DS} = 400V, f = 1.0\text{MHz}$
$C_{oss\ eff.}$	Effective Output Capacitance	—	28	—		$V_{GS} = 0V, V_{DS} = 0V$ to $400V$ ⑤

Avalanche Characteristics

	Parameter	Typ.	Max.	Units
E_{AS}	Single Pulse Avalanche Energy②	—	140	mJ
I_{AR}	Avalanche Current①	—	2.5	A
E_{AR}	Repetitive Avalanche Energy①	—	5.0	mJ

Thermal Resistance

	Parameter	Typ.	Max.	Units
$R_{\theta JC}$	Junction-to-Case	—	2.5	°C/W
$R_{\theta CS}$	Case-to-Sink, Flat, Greased Surface	0.50	—	
$R_{\theta JA}$	Junction-to-Ambient	—	62	

Diode Characteristics

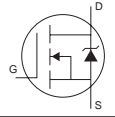
	Parameter	Min.	Typ.	Max.	Units	Conditions
I_S	Continuous Source Current (Body Diode)	—	—	2.5	A	MOSFET symbol showing the integral reverse p-n junction diode. 
I_{SM}	Pulsed Source Current (Body Diode) ①	—	—	10		
V_{SD}	Diode Forward Voltage	—	—	1.6	V	$T_J = 25^\circ\text{C}, I_S = 2.5A, V_{GS} = 0V$ ④
t_{rr}	Reverse Recovery Time	—	330	500	ns	$T_J = 25^\circ\text{C}, I_F = 2.5A$
Q_{rr}	Reverse Recovery Charge	—	760	1140	nC	$di/dt = 100A/\mu s$ ④
t_{on}	Forward Turn-On Time	Intrinsic turn-on time is negligible (turn-on is dominated by L_S+L_D)				

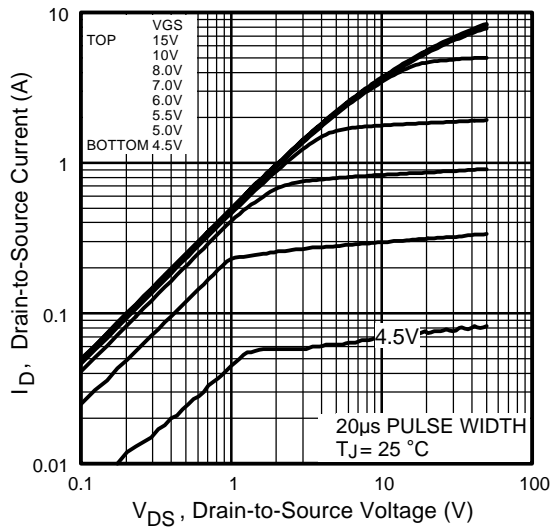

Fig 1. Typical Output Characteristics

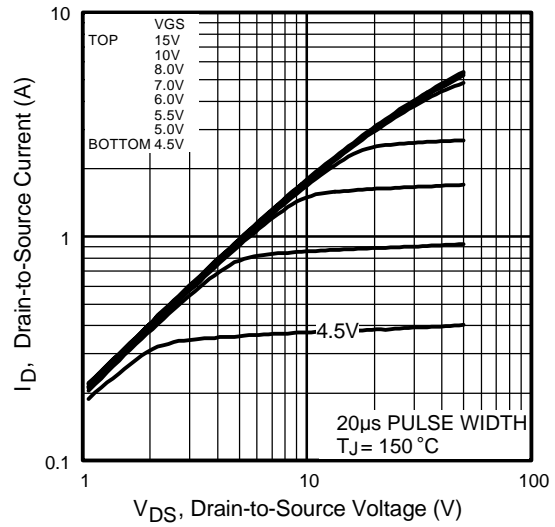

Fig 2. Typical Output Characteristics

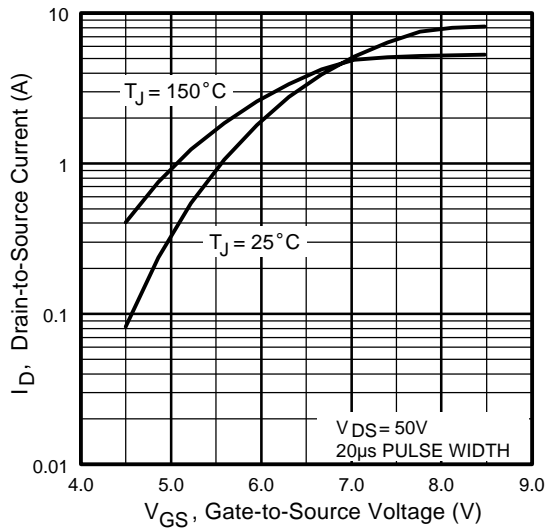

Fig 3. Typical Transfer Characteristics

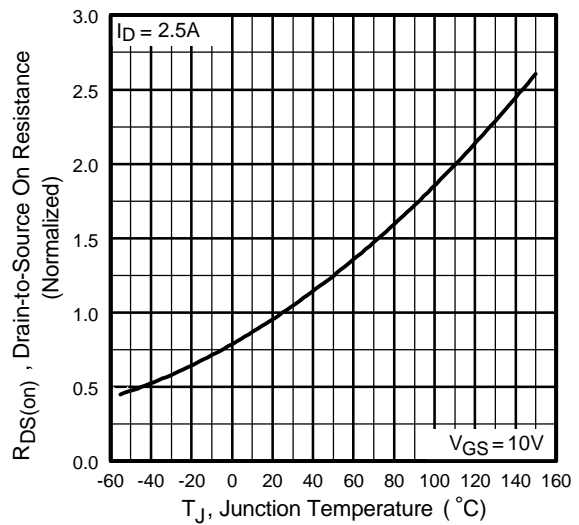

Fig 4. Normalized On-Resistance Vs. Temperature

IRF820A

International
IR Rectifier

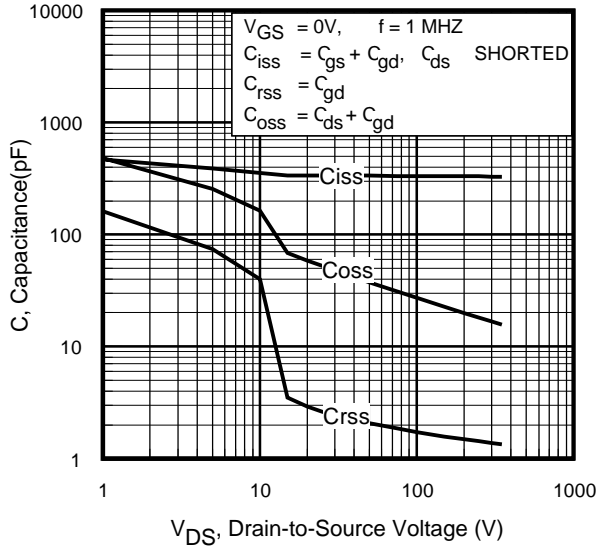

Fig 5. Typical Capacitance Vs. Drain-to-Source Voltage

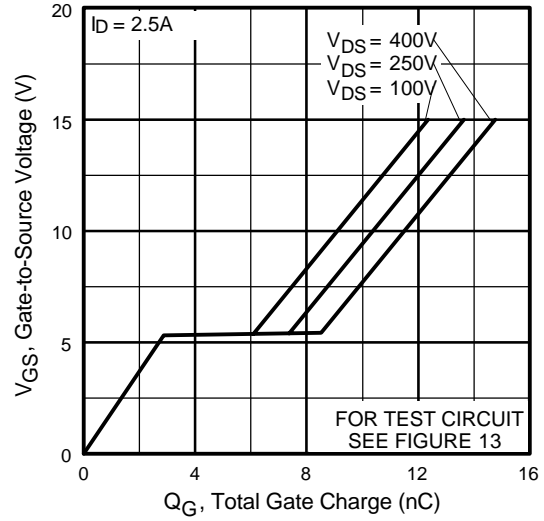

Fig 6. Typical Gate Charge Vs. Gate-to-Source Voltage

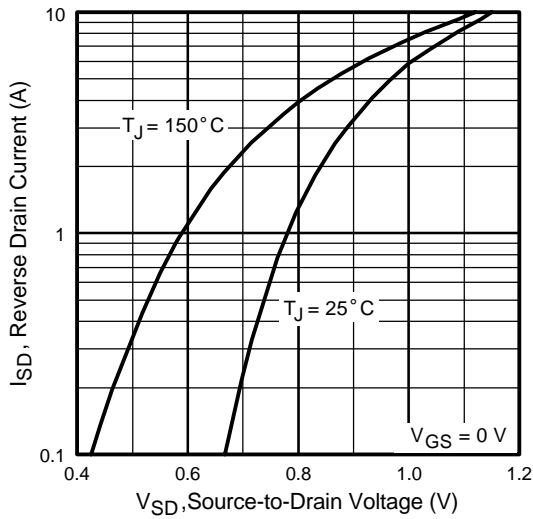

Fig 7. Typical Source-Drain Diode Forward Voltage

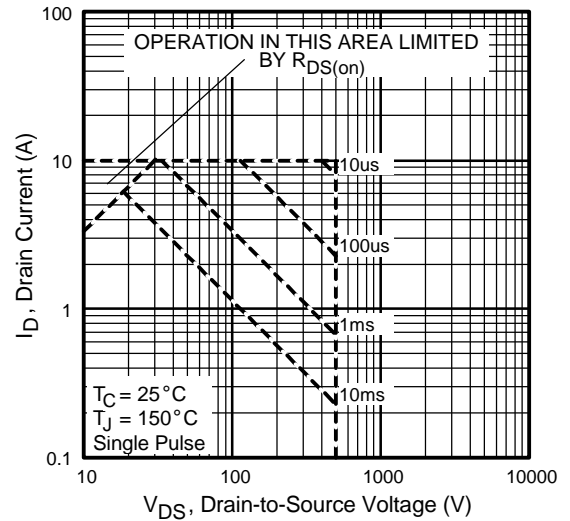

Fig 8. Maximum Safe Operating Area

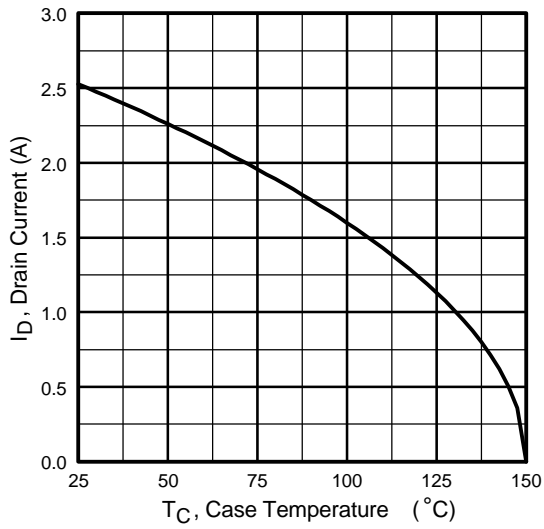

Fig 9. Maximum Drain Current Vs. Case Temperature



Fig 10a. Switching Time Test Circuit



Fig 10b. Switching Time Waveforms

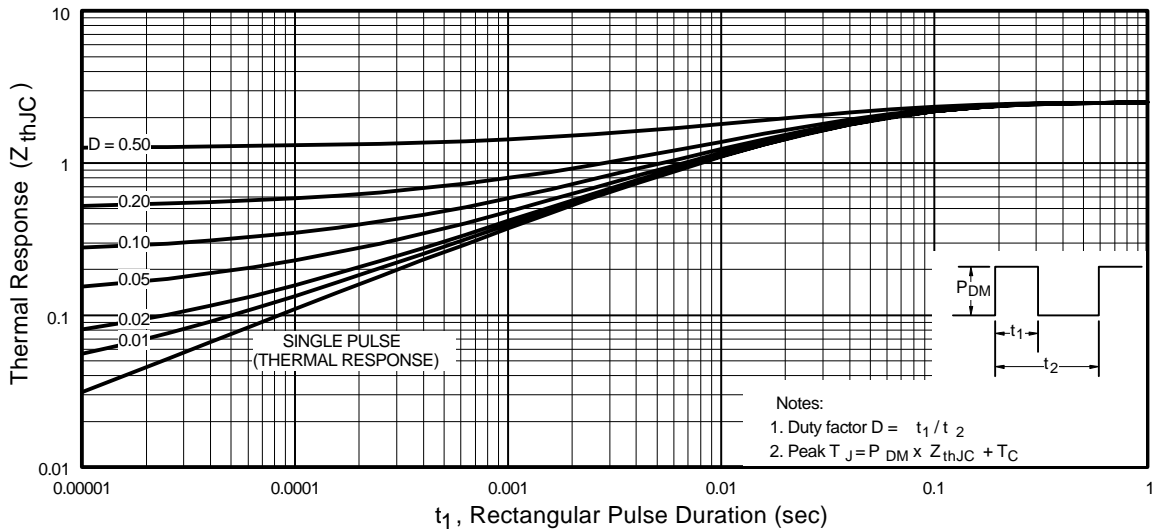

Fig 11. Maximum Effective Transient Thermal Impedance, Junction-to-Case

IRF820A

International
IR Rectifier



Fig 12a. Unclamped Inductive Test Circuit



Fig 12b. Unclamped Inductive Waveforms



Fig 13a. Basic Gate Charge Waveform



Fig 13b. Gate Charge Test Circuit

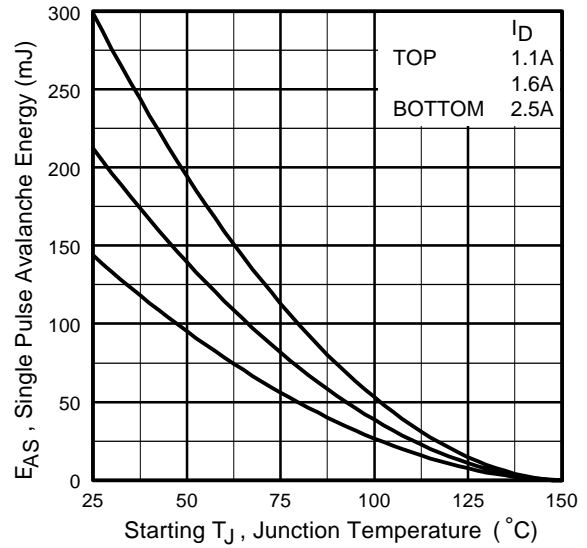

Fig 12c. Maximum Avalanche Energy Vs. Drain Current

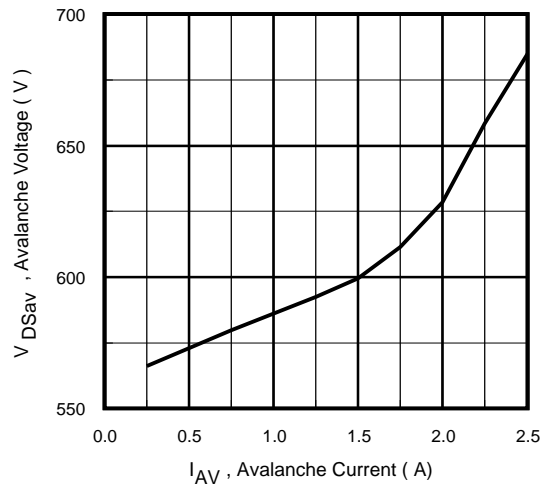

Fig 12d. Typical Drain-to-Source Voltage Vs. Avalanche Current

Peak Diode Recovery dv/dt Test Circuit



* $V_{GS} = 5V$ for Logic Level Devices

Fig 14. For N-Channel HEXFET® Power MOSFETs

IRF820A

International
IR Rectifier

Package Outline

TO-220AB

Dimensions are shown in millimeters (inches)

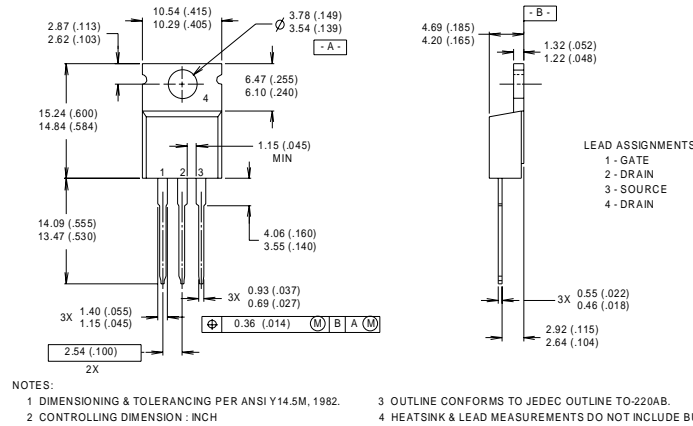

Part Marking Information

TO-220AB

EXAMPLE : THIS IS AN IRF1010
WITH ASSEMBLY
LOT CODE 9B1M

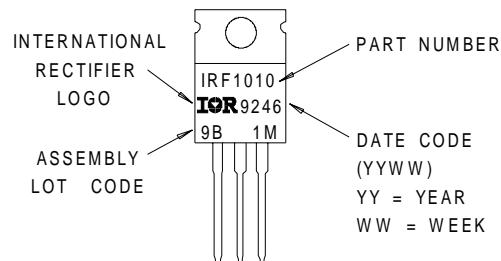

Notes:

- ① Repetitive rating; pulse width limited by max. junction temperature. (See fig. 11)
- ② Starting $T_J = 25^\circ\text{C}$, $L = 45\text{mH}$
 $R_G = 25\Omega$, $I_{AS} = 2.5\text{A}$. (See Figure 12)
- ③ $I_{SD} \leq 2.5\text{A}$, $di/dt \leq 270\text{A}/\mu\text{s}$, $V_{DD} \leq V_{(BR)DSS}$,
 $T_J \leq 150^\circ\text{C}$
- ④ Pulse width $\leq 300\mu\text{s}$; duty cycle $\leq 2\%$.
- ⑤ C_{OSS} eff. is a fixed capacitance that gives the same charging time as C_{OSS} while V_{DS} is rising from 0 to 80% V_{DSS}

International
IR Rectifier

IR WORLD HEADQUARTERS: 233 Kansas St., El Segundo, California 90245, USA Tel: (310) 252-7105
IR EUROPEAN REGIONAL CENTRE: 439/445 Godstone Rd, Whyteleafe, Surrey CR3 OBL, UK Tel: ++ 44 (0)20 8645 8000

IR CANADA: 15 Lincoln Court, Brampton, Ontario L6T3Z2, Tel: (905) 453 2200
IR GERMANY: Saalburgstrasse 157, 61350 Bad Homburg Tel: ++ 49 (0) 6172 96590

IR ITALY: Via Liguria 49, 10071 Borgaro, Torino Tel: ++ 39 011 451 0111

IR JAPAN: K&H Bldg., 2F, 30-4 Nishi-Ikebukuro 3-Chome, Toshima-Ku, Tokyo 171 Tel: 81 (0)3 3983 0086

IR SOUTHEAST ASIA: 1 Kim Seng Promenade, Great World City West Tower, 13-11, Singapore 237994 Tel: ++ 65 (0)838 4630

IR TAIWAN: 16 Fl. Suite D. 207, Sec. 2, Tun Haw South Road, Taipei, 10673 Tel: 886-(0)2 2377 9936

Data and specifications subject to change without notice. 5/00